



Simply Unique

Unique Single Seat Tank Outlet Valve

General Information

The new generation that meets the highest demands of your process in terms of hygiene and safety. Unique Single Seat Tank Outlet Valves are built on a well-proven, platform from an installed base of more than one million valves.

Application

Unique Single Seat Tank Outlet Valve is an air-operated seat valve in a hygienic and flexible design giving a wide field of applications, e.g. closing up against tank or open into tank with one or two ports.

Working principle

The valve is remote-controlled by means of compressed air. It has few and simple moveable parts which results in a very reliable valve and low maintenance cost.

Standard design

The Unique Single Seat Tank Outlet Valve consists of one body and a tank flange, which are clamped together. To ensure a high degree of flexibility the valve seat is loose. To reduce the wear of sealings there is a controlled compression of seals by metal to metal contact. The actuator comes with a 5 years warranty. The actuator is connected to the valve body using a yoke and all components are assembled with clamp rings. To facilitate installation the valve is only partly assembled when delivered. The valve has welding ends as standard and is available with fittings as option. The Unique Single Seat Tank Outlet Valve range covers the sizes from DN50 to DN100 and DN/OD 51 mm to 101.6 mm.

The body can be turned in any position if the clamps are slightly loosened. The tank flange is welded directly into the tank. (Important! Observe welding guideline in instruction manual) The tank flange is supplied with TÜV approval AD 2000 and inspection certificate 3.1 according to EN10204.

Other valves in the same basic design

- Single Seat valve.
- Reverse acting valve.
- Long stroke valve.
- Manually operated valve.
- Aseptic valve

Unique Single Seat Valve is designed, tested and approved according to EHEDG guidelines.



Unique Single Seat Tank Outlet Valve



Pressure drop/capacity diagrams

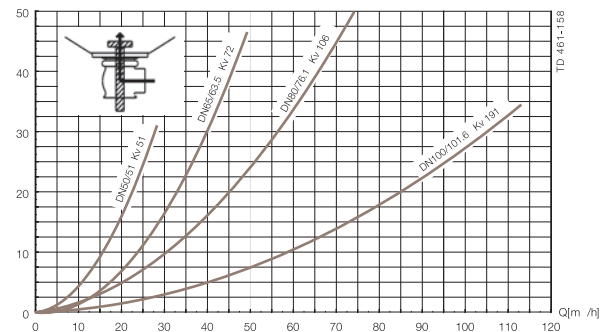
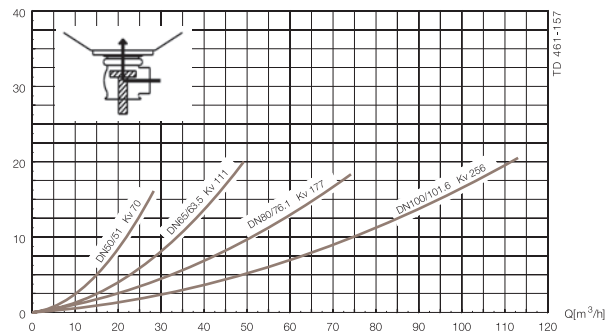
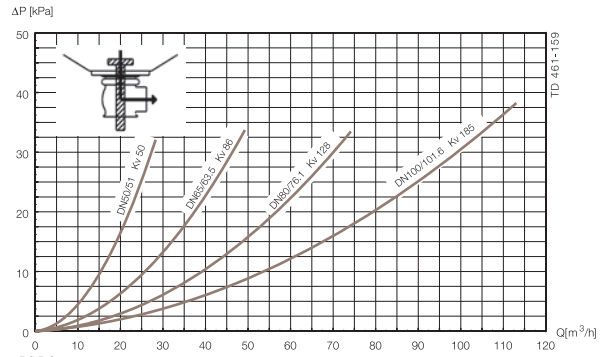
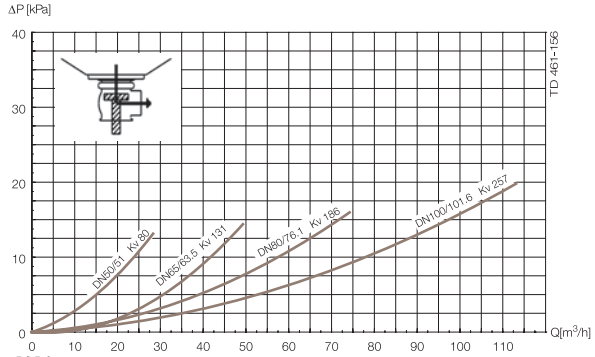

Note!

For the diagrams the following applies:

Medium: Water (20° C)

Measurement: In accordance with VDI2173

Pressure data for Unique Single Seat Tank Outlet Valve

Table 1

Max. pressure in bar without leakage at the valve seat

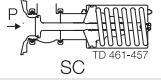
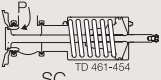
Actuator / Valve body combination and direction of pressure	DN50	DN 65	DN 80	DN 100
	DN/OD 51 mm	DN/OD 63.5 mm	DN/OD 76.1 mm	DN/OD 101.6 mm
 SC TD 461-457	7.2	4.2	6.4	4.2
 SC TD 461-454	8.4	4.5	6.8	4.4

P = Product pressure
SC = Spring closes

Table 2

Max. pressure in bar against which the valve can open.

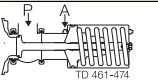
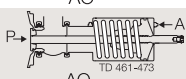
Actuator / Valve body combination and direction of pressure	Air pressure (bar)	Valve size			
		DN50 DN/OD 51 mm	DN 65 DN/OD 63.5 mm	DN 80 DN/OD 76.1 mm	DN 100 DN/OD 101.6 mm
 AO TD 461-474	6	10.0	9.0	10.0	6.9
 AO TD 461-473	6	10.0	8.3	9.9	6.6

A = Air
P = Product pressure
AO = Air opens

Dimensions (mm)

Size	51 mm	63.5 mm	76.1 mm	101.6 mm	DN 50	DN 65	DN 80	DN 100
A1	426	439	479	503	429	445	487	506
A2	393	406	446	470	396	412	454	473
A3	368	381	416	440	371	387	424	443
A4	390	403	443	467	393	409	451	470
A5	364	377	412	436	367	383	420	439
C	30	30	30	30	30	30	30	30
OD	51	63.5	76.1	101.6	53	70	85	104
ID	47.8	60.3	72.9	97.6	50	66	81	100
t	1.6	1.6	1.6	2	1.5	2	2	2
E	62	82	87	120	62	82	87	120
E1	67	73	79	92	68	76	84	93
F1	25	25	30	30	25	25	30	30
F2	26	26	31	31	26	26	31	31
øH	114.9	114.9	154.3	154.3	114.9	114.9	154.3	154.3
øJ	148	163	178	198	148	163	178	198
S	16	16	21	21	16	16	21	21
M/ISO clamp	21	21	21	21				
M/DIN clamp					21	28	28	28
M/DIN male					23	25	25	30
M/SMS male	20	24	24	35				
Weight (kg)								
Standard	7.1	8.3	13.3	15.9	7.1	8.5	13.8	15.9
Reverse Acting	7.2	8.4	13.5	16.1	7.2	8.6	14	16

A1= min. Installation measure to allow that valve can be lifted out of the tank flange / valve body (if Indication Unit is mounted, height must be add)

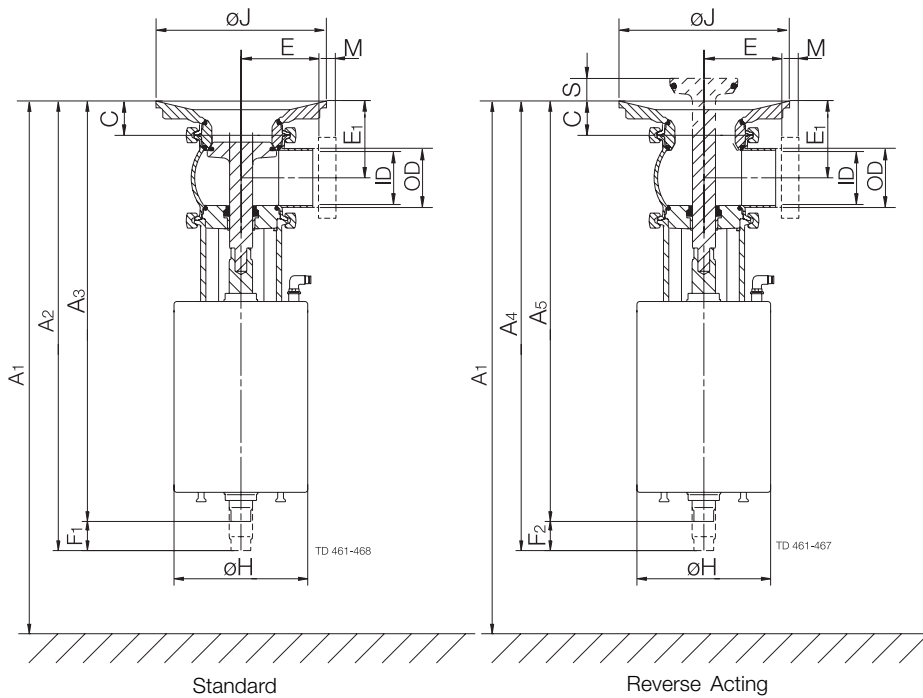

Caution, opening/closing time:

Opening/closing time will be effected by the following:

- The air supply (air pressure).
- The length and dimensions of the air hoses.
- Number of valves connected to the same air hose.
- Use of single solenoid valve for serial connected air actuator functions.
- Product pressure.

Air Connections Compressed air:

R 1/8" (BSP), internal thread.

Technical Data

Max. product pressure in pipeline (depends on valve specifications):1000 kPa (10 bar)
 Max. product pressure in tank (depends on valve specifications and temperature):1000 kPa (10 bar) if max. 20°C
850 kPa (8.5 bar) if max. 100°C
750 kPa (7.5 bar) if max. 150°C
 Max. product pressure in tank (higher pressure will open the valve)Choose actuator below - see table.
 Min. product pressure:Full vacuum.
 Temperature range:-10°C to +140°C (EPDM)
 Air pressure:500 to 700 kPa (5 to 7 bar).

Valve Body Combinations

Valve Body Combinations

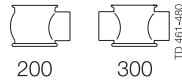

Actuator function

Air consumption (litres free air) for one stroke	
DN50-65 DN/OD 51-63.5 mm	DN80-100 DN/OD 76.1-101.6 mm
0.5 x air pressure [bar]	1.3 x air pressure [bar]

Materials

Product wetted steel parts:1.4404 (316L) (internal Ra < 0.8 µm)
 Other steel parts1.4301 (304)
 Plug seal:EPDM
 Optional plug seal:PTFE (TR2)
 Other product wetted seals:EPDM (standard)
 Optional product wetted seals:HNBR and FPM
 Other sealsNBR

Options

- A. Male parts or clamp liners in accordance with required standard.
- B. Control and Indication: IndiTop, ThinkTop and ThinkTop Basic.
- C. Aseptic version
- D. Product wetted seals in HNBR or FPM
- E. TR2 plug (floating PTFE design)
- F. High pressure actuator
- G. Manually operated
- H. NO or A/A actuator
- I. Long stroke actuator
- J. Maintainable actuator
- K. External surface finish bright

Ordering

Please state the following when ordering:

- Size.
- Connections if not welding ends.
- Valve body combination.
- Options.

Note!

For further details, see instruction ESE00305.

ESE00251EN 0608

The information contained herein is correct at the time of issue,
but may be subject to change without prior notice.

How to contact Alfa Laval

Contact details for all countries
are continually updated on our website.
Please visit www.alfalaval.com to
access the information direct.